

### Features

- Input Voltage Range: 18V to 60V
- 1500 VDC Isolation
- On/Off Control
- $V_o$  Adjust
- Differential Remote Sense
- Current Limit
- Short-Circuit Protection
- Over-Temperature Shutdown
- Undervoltage Lockout
- Space-Saving Package
- Solderable Copper Case
- UL1950 Recognized
- CSA 22.2 950 Certified
- EN60950 Approved
- VDE Licensed
- $5 \times 10^6$  Hrs MTBF
- Meets FCC Class A Radiated Limits

### Description

The PT4580 series is a single-output isolated DC/DC converter, housed in a 19-pin space-saving package. These modules are UL, CSA, and VDE approved for telecom applications, and rated at 30W or 8A. The 18V to 60V input range allows easy integration into many distributed power applications which utilize 24V bus architectures.

Standard output voltages range from 1.8V to 15V, and are each adjustable by up to  $\pm 10\%$ . Operating features include a *Remote On/Off* control, an under-voltage lockout (UVLO), and a differential remote sense. Protection features include an output current limit, short-circuit protection, and over-temperature shutdown.

A 330 $\mu$ F output capacitor is required for proper operation.

### Ordering Information

- PT4581□ = 3.3V/8A (26.4W)
- PT4582□ = 5.0V/6A
- PT4583□ = 12.0V/2.5A
- PT4584□ = 15.0V/2A
- PT4585□ = 1.8V/8A (14.4W)

### PT Series Suffix (PT1234 x)

Case/Pin Configuration	Order Suffix	Package Code *
Vertical	<b>N</b>	(END)
Horizontal	<b>A</b>	(ENA)
SMD	<b>C</b>	(ENC)

\* Previously known as package styles 1400 & 1410.

(Reference the applicable package code drawing for the dimensions and PC board layout)

### Pin-Out Information

Pin	Function
1	Do Not Use
2	Remote On/Off †
3	Do Not Use
4	- $V_{in}$
5	- $V_{in}$
6	- $V_{in}$
7	+ $V_{in}$
8	+ $V_{in}$
9	+ $V_{in}$
10	- $V_o$
11	- $V_o$
12	- $V_o$
13	-Remote Sense
14	+ $V_o$
15	+ $V_o$
16	+ $V_o$
17	+ $V_o$
18	$V_o$ Adjust †
19	+Remote Sense

† For more information, see application notes.

### Standard Application

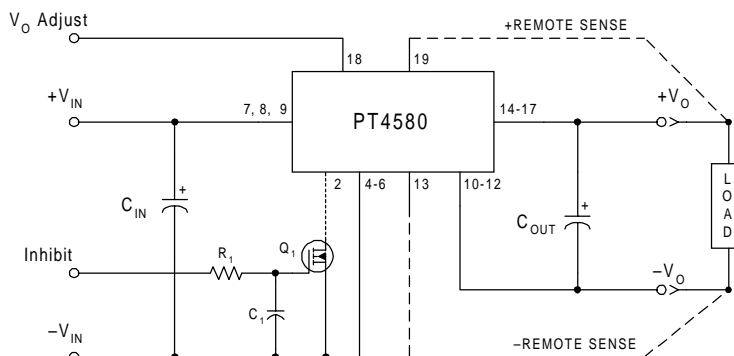

- $C_{in}$  = Optional 100 $\mu$ F/100V electrolytic
- $C_{out}$  = Required 330 $\mu$ F electrolytic (See Notes)
- $Q_1$  = N-Channel MOSFET
- $R_1/C_1$  = Optional (see application notes)

# PT4580 Series

30-W 24/48-V Input  
Isolated DC/DC Converter

**Specifications** (Unless otherwise stated,  $T_a = 25^\circ\text{C}$ ,  $V_{in} = 24\text{V}$ ,  $C_{out} = 330\mu\text{F}$ , and  $I_o = I_o(\text{max})$ )

Characteristic	Symbol	Conditions	PT4580 SERIES			Units		
			Min	Typ	Max			
Output Current	$I_o$	Over $V_{in}$ range	$V_o = 15\text{V}$	0.1 (1)	—	2.0	A	
			$V_o = 12\text{V}$	0.1 (1)	—	2.5		
			$V_o = 5.0\text{V}$	0.25 (1)	—	6.0		
			$V_o \leq 3.3\text{V}$	0.25 (1)	—	8.0		
Input Voltage Range	$V_{in}$	Over $I_o$ Range		18.0	24.0	60.0	V	
Set Point Voltage Tolerance	$V_o \text{ tol}$		$V_o \geq 5.0\text{V}$	—	$\pm 1$	$\pm 1.5$	$\%V_o$	
			$V_o \leq 3.3\text{V}$	—	$\pm 33$	$\pm 50$	mV	
Temperature Variation	$\text{Reg}_{\text{temp}}$	$-40^\circ \leq T_a \leq +85^\circ\text{C}$		—	$\pm 0.5$	—	$\%V_o$	
Line Regulation	$\text{Reg}_{\text{line}}$	Over $V_{in}$ range	$V_o \geq 5.0\text{V}$	—	$\pm 0.2$	$\pm 1.0$	$\%V_o$	
			$V_o \leq 3.3\text{V}$	—	$\pm 7$	$\pm 33$	mV	
Load Regulation	$\text{Reg}_{\text{load}}$	Over $I_o$ range	$V_o \geq 5.0\text{V}$	—	$\pm 0.4$	$\pm 1.0$	$\%V_o$	
			$V_o \leq 3.3\text{V}$	—	$\pm 13$	$\pm 33$	mV	
Total Output Voltage Variation	$\Delta V_{o\text{tot}}$	Includes set-point, line, load, $-40^\circ \leq T_a \leq +85^\circ\text{C}$	$V_o \geq 5.0\text{V}$	—	$\pm 2$	—	$\%V_o$	
			$V_o \leq 3.3\text{V}$	—	$\pm 67$	—	mV	
Efficiency	$\eta$		$V_o = 15\text{V}$	—	85	—	%	
			$V_o = 12\text{V}$	—	86	—		
			$V_o = 5.0\text{V}$	—	83	—		
			$V_o = 3.3\text{V}$	—	80	—		
			$V_o = 1.8\text{V}$	—	70	—		
$V_o$ Ripple (pk-pk)	$V_r$	20MHz bandwidth	$V_o \geq 5.0\text{V}$	—	1.0	2.0	$\%V_o$	
			$V_o \leq 3.3\text{V}$	—	50	75	mV <sub>pp</sub>	
Transient Response	$t_{tr}$	0.1A/ $\mu\text{s}$ load step, 50% to 100% $I_o(\text{max})$		—	100	200	$\mu\text{s}$	
		$\Delta V_{tr}$	$V_o$ over/undershoot	$V_o \geq 5.0\text{V}$	—	$\pm 3.0$	$\pm 5.0$	$\%V_o$
			$V_o \leq 3.3\text{V}$	—	$\pm 100$	$\pm 150$	mV	
Short Circuit Current	$I_{sc}$			—	$2 \times I_o(\text{max})$	—	A	
Switching Frequency	$f_s$	Over $V_{in}$ range	$V_o \geq 10\text{V}$	450	500	550	kHz	
			$V_o < 10\text{V}$	700	750	800		
Under-Voltage Lockout	UVLO	$V_{in}$ increasing		—	17	—	V	
		$V_{in}$ decreasing		—	16	—		
Remote On/Off Input (pin 2)	$V_{IH}$ $V_{IL}$ $I_{IL}$	Referenced to $-V_{in}$ (pins 4–6)		2.5	—	15 (2)	V	
				–0.2	—	+0.8		
				–3	–6	–10		$\mu\text{A}$
Standby Input Current	$I_{in \text{ standby}}$	pins 2 & 4 connected		—	8	16	mA	
Internal Input Capacitance	$C_{in}$			—	0.66	—	$\mu\text{F}$	
External Output Capacitance	$C_{out}$	Between $+V_o$ and $-V_o$	$V_o \geq 9.0\text{V}$	260	330	600 (3)	$\mu\text{F}$	
			$V_o \leq 5.0\text{V}$	260	330	1,000 (3)		
Isolation Voltage Capacitance Resistance		Input-output/input-case		1500	—	—	V <sub>dc</sub>	
		Input-output		—	1200	—	pF	
		Input-output		10	—	—	M $\Omega$	
Operating Temperature Range	$T_a$	Over $V_{in}$ range		–40 (4)	—	+85 (5)	$^\circ\text{C}$	
Maximum Case Temperature	$T_c$			—	—	100	$^\circ\text{C}$	
Storage Temperature Range	$T_s$			–40	—	+125	$^\circ\text{C}$	
Reliability	MTBF	Per Bellcore TR-332 50% stress, $T_a = 40^\circ\text{C}$ , ground benign		5.0	—	—	10 <sup>6</sup> Hrs	
Mechanical Shock	—	Per Mil-Std-883D, method 2002.3, 1mS, half-sine, mounted to a fixture		—	500	—	G's	
Mechanical Vibration	—	Per Mil-Std-883D, method 2007.2, 20-2000Hz, soldered to board		—	20	—	G's	
Weight	—			—	40	—	grams	
Flammability	—	Materials meet UL 94V-0						

**Notes:** (1) The DC/DC converter will operate at no load with reduced specifications.

(2) The Remote On/Off input has an internal pull-up. If it is left open circuit the converter will operate when input power is applied. A low-leakage (<100nA) MOSFET is recommended to control this input. The open-circuit voltage is less than 10V. See application notes for interface considerations.

(3) Output capacitor values are absolute. Allowances must be made for any additional de-coupling capacitors and the total external capacitor tolerance.

The value of external capacitance is limited due to regulator startup current requirements. Consult the factory for further details.

(4) For operation below  $0^\circ\text{C}$ , the required external output capacitor must have temperature stable characteristics. E.g. Tantalum or Oscon® types.

(5) See Safe Operating Area curves or contact the factory for the appropriate thermal derating.

# PT4580 Series

30-W 24/48-V Input  
Isolated DC/DC Converter

## PT4581, 3.3 VDC (See Note A)

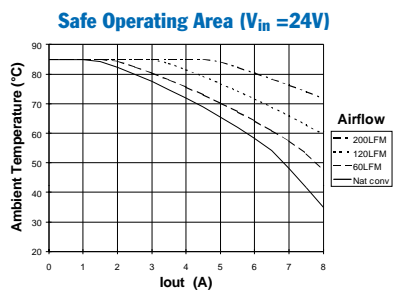
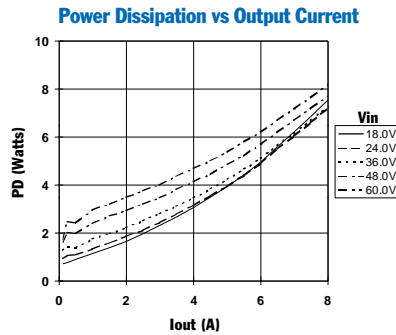
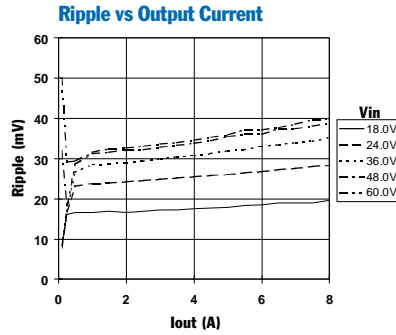
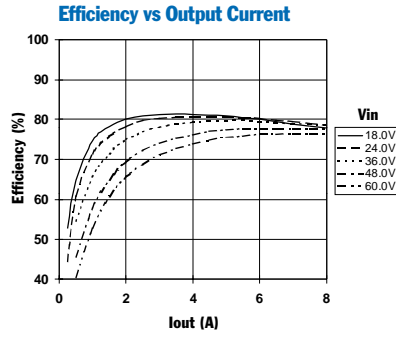

## PT4582, 5.0 VDC (See Note A)

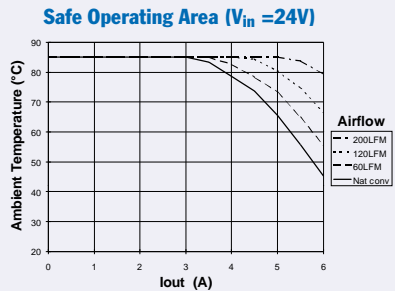
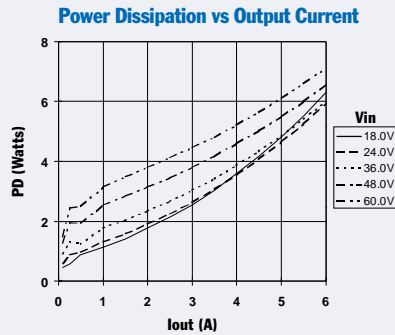
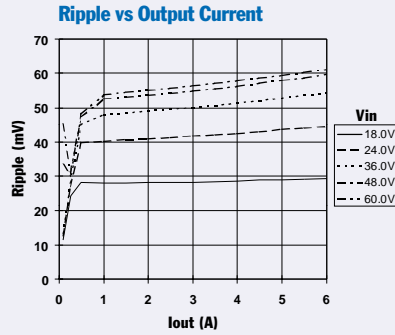
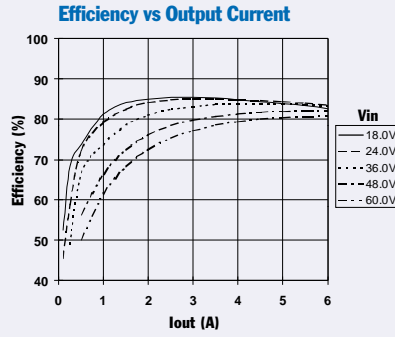

## PT4583, 12.0 VDC (See Note A)

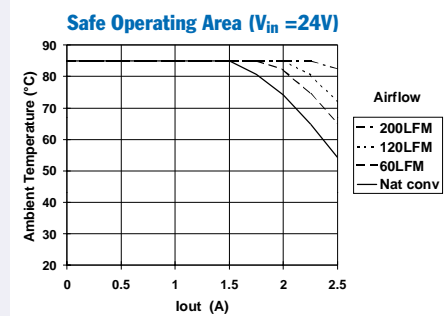
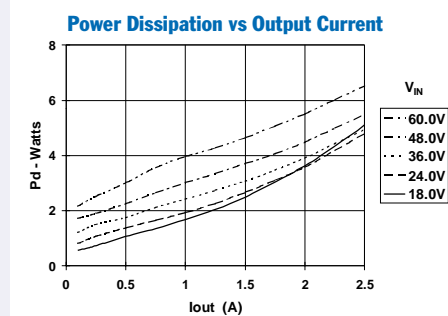
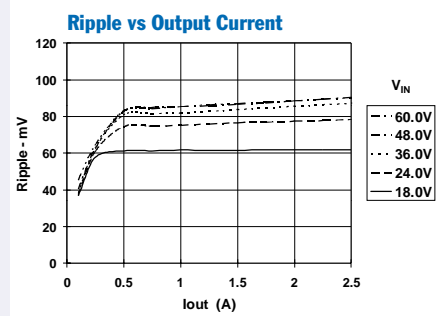
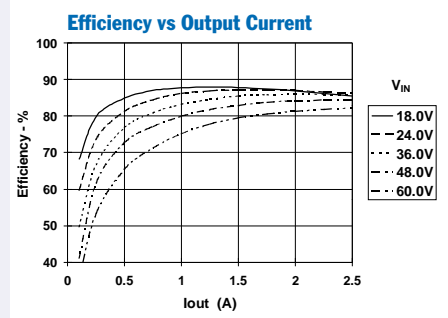

**Note A:** All data listed in the above graphs has been developed from actual products tested at 25°C. This data is considered typical data for the DC-DC Converter.  
**Note B:** SOA Curves represent operating conditions at which internal components are at or below manufacturer's maximum rated operating temperatures.

## Adjusting the Output Voltage of Power Trends' 30W Isolated DC/DC Converter Series

The factory pre-set output voltage of Power Trends' 30W series of isolated DC/DC converters may be adjusted within a nominal  $\pm 10\%$  range. This is accomplished with the addition of a single external resistor. For the input voltage range specified in the data sheet, Table 1 gives the allowable adjustment range for each model as  $V_o$  (min) and  $V_o$  (max).

**Adjust Up:** An increase in the output voltage is obtained by adding a resistor,  $R_2$  between  $V_o$  adjust (pin 18), and -Remote Sense (pin 13). See note 4.

**Adjust Down:** Add a resistor ( $R_1$ ), between  $V_o$  adjust (pin 18), and +Remote Sense (pin 19).

Refer to Figure 1 and Tables 2 & 3 for both the placement and value of the required resistor, ( $R_1$ ) or  $R_2$ .

### Notes:

1. Use only a single 1% resistor in either the ( $R_1$ ) or  $R_2$  location. Place the resistor as close to the ISR as possible.
2. Never connect capacitors to  $V_o$  adjust. Any capacitance added to the  $V_o$  adjust control pin will affect the stability of the ISR.

3. If the remote sense pins are not being used, the resistors ( $R_1$ ) and  $R_2$  can be connected to  $+V_{out}$  or  $-V_{out}$  respectively.
4. The adjusted output voltage,  $V_a$  effectively sets the voltage across pins 13 and 19 ( $\pm$ Remote Sense). When using the remote sense pins,  $V_{out}$  (measured directly across pins 10–12, and 14–17) can be significantly higher than  $V_a$ , and may exceed  $V_o$  (max). If  $V_a$  is adjusted upward of  $V_o$ (max), the minimum input voltage is increased by the same percentage as  $V_{out}$  exceeds  $V_o$ (max).

The values of ( $R_1$ ) [adjust down], and  $R_2$  [adjust up], can also be calculated using the following formulas.

$$(R_1) = \frac{K_o (V_a - V_r)}{V_r (V_o - V_a)} - R_s \quad \text{k}\Omega$$

$$R_2 = \frac{K_o}{(V_a - V_o)} - R_s \quad \text{k}\Omega$$

Where  $V_o$  = Original output voltage  
 $V_a$  = Adjusted output voltage  
 $V_r$  = Reference voltage (Table 1)  
 $K_o$  = Multiplier constant (Table 1)  
 $R_s$  = Series resistance (Table 1)

Table 1

### DC/DC CONVERTER ADJUSTMENT RANGE AND FORMULA PARAMETERS

Series Pt #									
<b>AL Case:</b>									
24V Bus					PT3341	PT3342		PT3343	PT3344
48V Bus	PT3327	PT3325	PT3326		PT3321	PT3322		PT3323	PT3324
<b>CU Case:</b>									
24V Bus	PT4585				PT4581	PT4582		PT4583	PT4584
48V Bus	PT4567	PT4565	PT4566		PT4561	PT4562	PT4571	PT4563	PT4564
$V_o$ (nom)	1.8V	1.8V	2.0V	2.5V	3.3V	5.0V	9.0V	12.0V	15.0V
$V_o$ (min)	1.62V	1.62V	1.8V	2.25V	2.95V	4.5V	7.0V	10.8V	13.5V
$V_o$ (max)	2.5V	1.98V	2.2V	2.75V	3.65V	5.5V	10.0V	13.2V	16.5V
$V_r$	1.225V	1.225V	1.225V	1.225V	1.225V	1.225V	2.5V	2.5V	2.5V
$K_o$ (V·k $\Omega$ )	69.58	69.58	62.47	42.33	68.89	68.71	133.25	135.9	137.5
$R_s$ (k $\Omega$ )	80.6	80.6	150.0	121.0	150.0	121.0	110	90.9	80.6

Figure 1

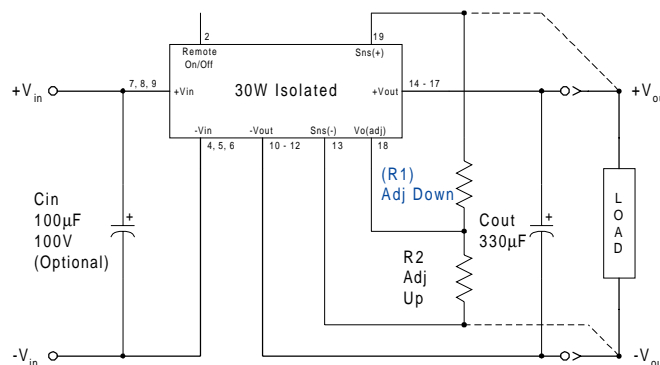

**Table 2**

**DC/DC CONVERTER ADJUSTMENT RESISTOR VALUES**

Series Pt #					
<b>Al Case</b>					
24V Bus					PT3341
48V Bus	PT3327	PT3325	PT3326	PT3321	
<b>CU Case</b>					
24V Bus	PT4585				PT4581
48V Bus	PT4567	PT4565	PT4566	PT4561	
Current	8A <sub>dc</sub>	8A <sub>dc</sub>	8A <sub>dc</sub>	8A <sub>dc</sub>	8A <sub>dc</sub>
V <sub>o</sub> (nom)	1.8V	1.8V	2.0V	2.5V	3.3V
<b>V<sub>a</sub>(req'd)</b>					
1.65	(80.3)kΩ	(80.3)kΩ			
1.7	(189.0)kΩ	(189.0)kΩ			
1.75	(516.0)kΩ	(516.0)kΩ			
1.8					
1.85	1.31MΩ	1.31MΩ	(62.5)kΩ		
1.9	615.0kΩ	615.0kΩ	(194.0)kΩ		
1.95	383.0kΩ	383.0kΩ	(589.0)kΩ		
2.0	267.0kΩ				
2.05	198.0kΩ	1.1MΩ			
2.1	151.0kΩ	475.0kΩ			
2.15	118.0kΩ	266.0kΩ			
2.2	93.3kΩ	162.0kΩ			
2.25	74.0kΩ				(20.7)kΩ
2.3	58.6kΩ				(64.7.0)kΩ
2.35	45.9kΩ				(138.0)kΩ
2.4	35.4kΩ				(285.0)kΩ
2.45	26.4kΩ				(726.0)kΩ
2.5	18.8kΩ				
2.55				726.0kΩ	
2.6				302.0kΩ	
2.65				161.0kΩ	
2.7				90.6kΩ	
2.75				48.3kΩ	
2.95				(127.0)kΩ	
3.0				(183.0)kΩ	
3.05				(261.0)kΩ	
3.1				(377.0)kΩ	
3.15				(572.0)kΩ	
3.2				(961.0)kΩ	
3.25				(2.13)MΩ	
3.3					
3.35	1.23MΩ				
3.4	539.0kΩ				
3.45	309.0kΩ				
3.5	194.0kΩ				
3.55	126.0kΩ				
3.6	79.6kΩ				
3.65	46.8kΩ				

R1 = (Blue)      R2 = Black

**Table 3**

**DC/DC CONVERTER ADJUSTMENT RESISTOR VALUES**

Series Pt #

AL Case

24V Bus	PT3342	PT3343	PT3344
48V Bus	PT3322	PT3323	PT3324
<b>CU Case</b>			
24V Bus	PT4582	PT4583	PT4584
48V Bus	PT4562	PT4571	PT4563
Current	6Adc	3.3Adc	2.5Adc
V <sub>o</sub> (nom)	5.0V	9.0V	12.0V
		15.0V	

V <sub>a</sub> (req'd)		V <sub>a</sub> (req'd)	
4.5	(246.0)kΩ	7.0	(9.9)kΩ
4.55	(293.0)kΩ	7.2	(29.2)kΩ
4.6	(352.0)kΩ	7.4	(53.2)kΩ
4.65	(428.0)kΩ	7.6	(84.2)kΩ
4.7	(529.0)kΩ	7.8	(125.0)kΩ
4.75	(670.0)kΩ	8.0	(183.0)kΩ
4.8	(882.0)kΩ	8.2	(270.0)kΩ
4.85	(1.23)MΩ	8.4	(414.0)kΩ
4.9	(1.94)MΩ	8.6	(703.0)kΩ
4.95		8.8	(1.57)MΩ
5.0		9.0	
5.05		9.2	556.0kΩ
5.1	566.0kΩ	9.4	223.0kΩ
5.15	337.0kΩ	9.6	112.0kΩ
5.2	223.0kΩ	9.8	56.6kΩ
5.25	154.0kΩ	10.0	23.3kΩ
5.3	108.0kΩ	•	
5.35	75.3kΩ	10.8	(285.0)kΩ
5.4	50.8kΩ	11.0	(371.0)kΩ
5.45	31.7kΩ	11.2	(500.0)kΩ
5.5	16.4kΩ	11.4	(715.0)kΩ
		11.6	(1.15)MΩ
		11.8	
		12.0	
		12.2	588.0kΩ
		12.4	249.0kΩ
		12.6	136.0kΩ
		12.8	78.9kΩ
		13.0	45.0kΩ
		13.2	22.3kΩ
		•	
		13.5	(323.0)kΩ
		13.6	(355.0)kΩ
		13.8	(437.0)kΩ
		14.0	(522.0)kΩ
		14.2	(724.0)kΩ
		14.4	(1010.0)kΩ
		14.6	(1.58)MΩ
		14.8	
		15.0	
		15.2	607.0kΩ
		15.4	263.0kΩ
		15.6	149.0kΩ
		15.8	91.3kΩ
		16.0	56.9kΩ
		16.5	11.1kΩ

R1 = (Blue)    R2 = Black

## Using Remote On/Off on Power Trends' 30W Isolated DC-DC Converter Series

Power Trends' 30W isolated series of DC/DC converters incorporate a *Remote On/Off* function. This function may be used in applications for battery conservation, power-up/shutdown sequencing, or to co-ordinate the power-up of the regulator for active in-rush current control. (See TI application reports, SLTA021, and SLUA250).

The Remote On/Off function is provided by pin 2. If pin 2 is left open-circuit, the converter provides a regulated output whenever a valid source voltage <sup>1</sup> is applied between +V<sub>in</sub> (pins 7-9), and -V<sub>in</sub> (pins 4-6). Applying a low voltage <sup>2</sup>, with respect to -V<sub>in</sub> (pin 2), disables the regulator output <sup>3</sup>. Table 1 details the control requirements for this input. Figure 1 shows how a discrete MOSFET (Q<sub>1</sub>) may be referenced to the negative input voltage rail to control the Remote On/Off pin.

**Table 1 Remote On/Off Control Requirements <sup>2</sup>**

Parameter	min	max
Enable (V <sub>IH</sub> )	2.5V <sup>5</sup>	15V (or open circuit) <sup>4</sup>
Disable (V <sub>IL</sub> )	-0.3V	0.8V

### Notes:

1. These converters incorporate an “Under Voltage Lockout” (UVLO) function. This function automatically holds the converter output in the “Off” state until there is sufficient input voltage for the converter to produce a regulated output. Table 2 gives the applicable UVLO thresholds.

**Table 2 UVLO Thresholds**

Series	UVLO Threshold	V <sub>in</sub> Range
PT3320/4560	34 ± 2.0V	36 – 75V
PT3340/4580	16.5 ± 1.5V	18 – 60V

- The Remote On/Off control pin uses -V<sub>in</sub> (pins 4-6) as its ground reference. All voltages specified are with respect to -V<sub>in</sub>.
- When the converter output is disabled the current drawn from the input supply is typically reduced to 8mA (16mA maximum).
- The internal circuitry comprises of a high impedance (3μA -10μA) current source. The open-circuit voltage is less than 10V.
- The Remote On/Off pin is ideally controlled using devices with an open-collector (or open-drain) output. A small low-leakage MOSFET (<100nA) is recommended. A pull-up resistor is not required, but may be necessary to ensure that the Remote On/Off pin exceeds V<sub>IH</sub>(min) (see Table 1). *Do not* use a pull-up resistor to the +V<sub>in</sub> input, or drive the pin above V<sub>IH</sub>(max).

- Keep the on/off transition to less than 1ms. This prevents erratic operation of the ISR, whereby the output voltage may drift un-regulated between 0V and the rated output voltage during power-up.
- In Figure 1, Q<sub>1</sub> is a low-threshold MOSFET. The components R<sub>1</sub> and C<sub>1</sub> are added to improve noise susceptibility.

**Figure 1**

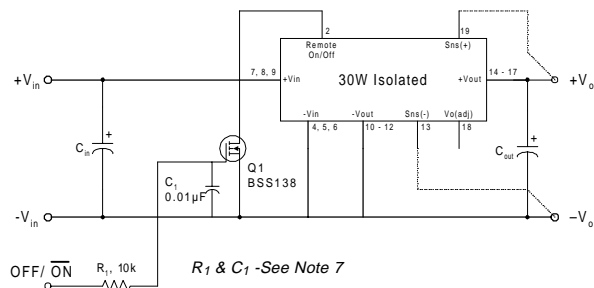

**Turn-On Time:** When the Remote On/Off input is left open-circuit, the output of the converter is automatically enabled when a valid input voltage <sup>1</sup> is applied to the input power pins. The converter typically rises to full regulation within 30ms of the application of power (or after the release of the Remote On/Off pin with input power applied). The actual turn-on time will vary with the input voltage, output load, and the total amount of capacitance connected to the output. Using the circuit of Figure 1, Figure 2 shows the typical output voltage and input current waveforms for a PT3322/PT4562 after Q<sub>1</sub> is turned off. The turn off of Q<sub>1</sub> correlates with the fall of the Q<sub>1</sub> V<sub>gs</sub> waveform. The waveforms were measured with a 48Vdc input voltage, and 5-A resistive load.

**Figure 2**

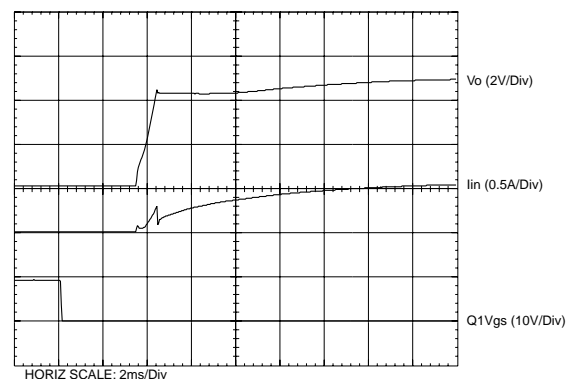

## VDE Approved Installation Instructions (Installationsanleitung)

Nennspannung (Rated Voltage):	PT4560 36 to 72 Vdc, Transient to 75Vdc PT4580 18 to 60 Vdc, PT4599 19 to 31 Vdc
Nennaufnahme (Rated Input):	PT4560 1.5 Adc PT4580, PT4599 3.0 Adc
Nennleistung (Rated Power):	30 Watts Maximum
Ausgangsspannung (Sec. Voltage):	PT4560 Series PT4561, 3.3 Vdc, 8.0 Adc PT4562, 5.0 Vdc, 6.0 Adc PT4580 Series PT4581, 3.3 Vdc, 8.0 Adc PT4582, 5.0 Vdc, 6.0 Adc
Ausgangsstrom (Sec. Current): oder (or)	PT4563, 12.0 Vdc, 2.5 Adc PT4564, 15.0 Vdc, 2.0 Adc PT4583, 12.0 Vdc, 2.5 Adc PT4584, 15.0 Vdc, 2.0 Adc
Ausgangsleistung (Sec. Power):	PT4565, 2.0 Vdc, 8.0 Adc PT4566, 2.5 Vdc, 8.0 Adc PT4567, 1.8 Vdc, 8.0 Adc PT4568, 5.2 Vdc, 6.0 Adc PT4569, 6.0 Vdc, 5.0 Adc PT4570, 8.0 Vdc, 3.75 Adc PT4571, 9.0 Vdc, 3.3 Adc PT4585, 1.8 Vdc, 8.0 Adc PT4599, 5.0 Vdc, 6.0 Adc

### Angabe der Umgebungstemperatur

(Information on ambient temperature): +85°C Ambient or 100°C Case Maximum

### Besondere Hinweise (Special Instructions):

Es ist vorzusehen, daß die Spannungsversorgung in einer Endanwendung über eine isolierte Sekundärschaltung bereit gestellt wird. Die Eingangsspannung der Spannungsversorgungsmodule muss eine verstärkte Isolierung von der Wechselstromquelle aufweisen.

Die Spannungsversorgung muss gemaess den Gehaeuse-, Montage-, Kriech- und Luftstrecken-, Markierungs- und Trennanforderungen der Endanwendung installiert werden. Bei Einsatz eines TNV-3-Einganges muss die SELV-Schaltung ordnungsgemaess geerdet werden.

(The power supply is intended to be supplied by isolated secondary circuitry in an end use application. The input power to these power supplies shall have reinforced insulation from the AC mains.)

The power supply shall be installed in compliance with the enclosure, mounting, creepage, clearance, casualty, markings, and segregation requirements of the end-use application. When the input is TNV-3, the SELV circuitry must be reliably grounded.)

Offenbach,

**VDE Prüf- und Zertifizierungsinstitut**  
Abteilung / Department TD

(Jürgen Bärwinkel)

Ort / Place:

Datum / Date:

*K. Yena* 12/12/01

(Stempel und Unterschrift des Herstellers / Stamp  
and signature of the manufacturer)



## IMPORTANT NOTICE

Texas Instruments Incorporated and its subsidiaries (TI) reserve the right to make corrections, modifications, enhancements, improvements, and other changes to its products and services at any time and to discontinue any product or service without notice. Customers should obtain the latest relevant information before placing orders and should verify that such information is current and complete. All products are sold subject to TI's terms and conditions of sale supplied at the time of order acknowledgment.

TI warrants performance of its hardware products to the specifications applicable at the time of sale in accordance with TI's standard warranty. Testing and other quality control techniques are used to the extent TI deems necessary to support this warranty. Except where mandated by government requirements, testing of all parameters of each product is not necessarily performed.

TI assumes no liability for applications assistance or customer product design. Customers are responsible for their products and applications using TI components. To minimize the risks associated with customer products and applications, customers should provide adequate design and operating safeguards.

TI does not warrant or represent that any license, either express or implied, is granted under any TI patent right, copyright, mask work right, or other TI intellectual property right relating to any combination, machine, or process in which TI products or services are used. Information published by TI regarding third-party products or services does not constitute a license from TI to use such products or services or a warranty or endorsement thereof. Use of such information may require a license from a third party under the patents or other intellectual property of the third party, or a license from TI under the patents or other intellectual property of TI.

Reproduction of information in TI data books or data sheets is permissible only if reproduction is without alteration and is accompanied by all associated warranties, conditions, limitations, and notices. Reproduction of this information with alteration is an unfair and deceptive business practice. TI is not responsible or liable for such altered documentation.

Resale of TI products or services with statements different from or beyond the parameters stated by TI for that product or service voids all express and any implied warranties for the associated TI product or service and is an unfair and deceptive business practice. TI is not responsible or liable for any such statements.

### Mailing Address:

Texas Instruments  
Post Office Box 655303  
Dallas, Texas 75265